

HK SHOOTERS

14

ANNIVERSARY

叮叮盃

# HK SHOOTERS

# 14

ANNIVERSARY

叮叮盞

SCORE MOST POINTS  
IN LIMITED TIME

Ding Ding Plate (DD)	1 Point
Popper (PP)	1 Point
Bonus	2 Point
Super Bonus	5 Point

# HK SHOOTERS

## STAGE 1

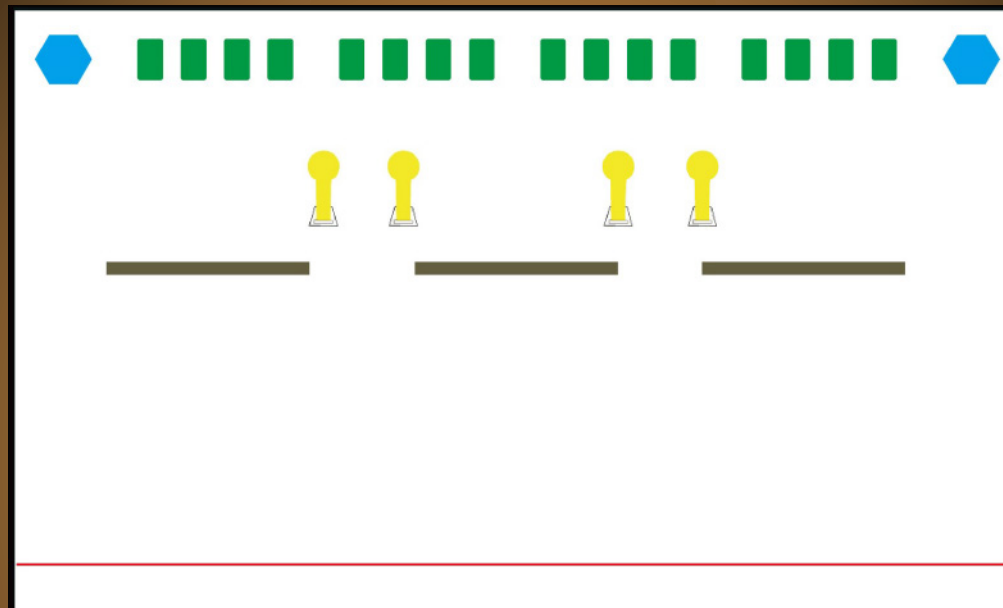

START ANYWHERE

Ding Ding Plate (DD) x **16**

Popper (PP) x **4**

Bonus x **2**

Super Bonus x **-**

14

ANNIVERSARY

叮叮盞



# HK SHOOTERS

## STAGE 2

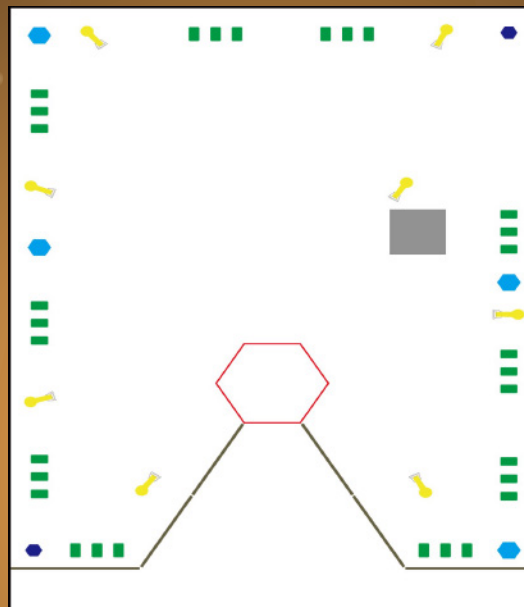

ENGAGE IN FIRING BOX

Ding Ding Plate (DD) x **30**

Popper (PP) x **8**

Bonus x **4**

Super Bonus x **2**

14

ANNIVERSARY

叮叮盞



# HK SHOOTERS

## STAGE 3

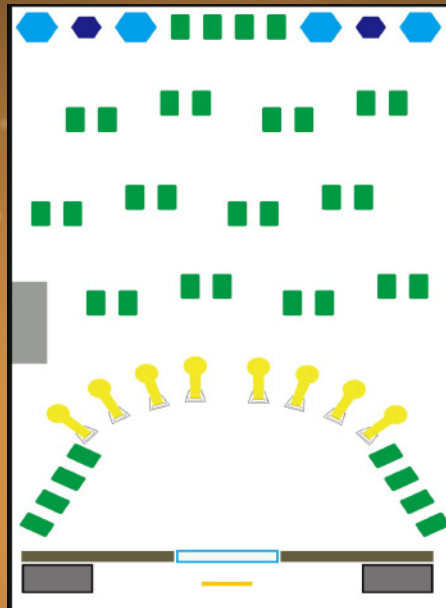

GUN EMPTY CHAMBER EMPTY ,  
ENGAGE THROUGH WINDOW ONLY

Ding Ding Plate (DD) x **36**

Popper (PP) x **8**

Bonus x **4**

Super Bonus x **2**

14

ANNIVERSARY

叮叮盞

# HK SHOOTERS

## STAGE 4

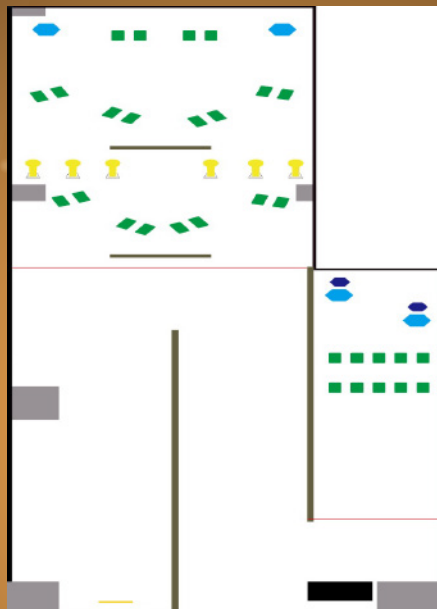

Ding Ding Plate (DD) x **30**

Popper (PP) x **6**

Bonus x **4**

Super Bonus x **2**

14

ANNIVERSARY

叮叮盞



# HK SHOOTERS

## STAGE 5

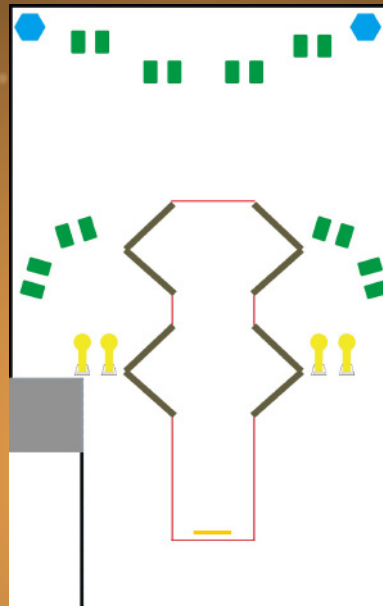

GUN LOADED CHAMBER EMPTY  
FACE UP RANGE SURRENDER

Ding Ding Plate (DD) x **16**

Popper (PP) x **4**

Bonus x **2**

Super Bonus x **-**

**14**

ANNIVERSARY

叮叮盃



# HK SHOOTERS

## STAGE 6

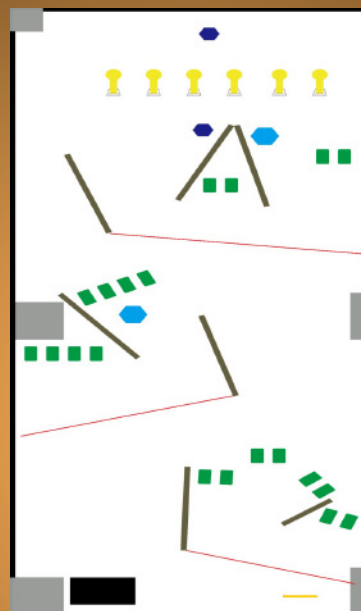

Ding Ding Plate (DD) x **20**

Popper (PP) x **6**

Bonus x **2**

Super Bonus x **2**

14

ANNIVERSARY

叮叮盃

# HK SHOOTERS

## STAGE 7

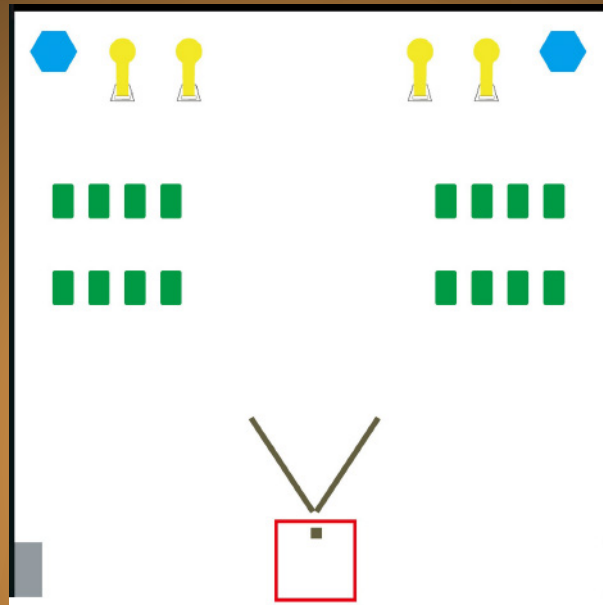

ENGAGE WITH STRONG HAND / WEAK HAND ONLY,  
REST HAND MUST HOLD THE ROD WHEN ENGAGING TARGETS

Ding Ding Plate (DD) x **16**

Popper (PP) x **4**

Bonus x **2**

Super Bonus x **-**

# 14

ANNIVERSARY

叮叮盞